

INFORMATION TABLE

Type of profile	Visible element [mm]	Joint width [mm]	Height of profile [mm]	Material	Load bearing capacity lorris (DIN 1072) [kN]	Load bearing capacity forklift trucks (DIN 1055) [kN]	Load bearing capacity vehicles with solid plastic tyres [kg/mm]	Movements horizontal/vertical [mm]
HDS 285.30.25	285	65	25	Aluminum	600	130	15	60(±30)/30(±15)

CONECTO HDS 285.30.25
VIEW

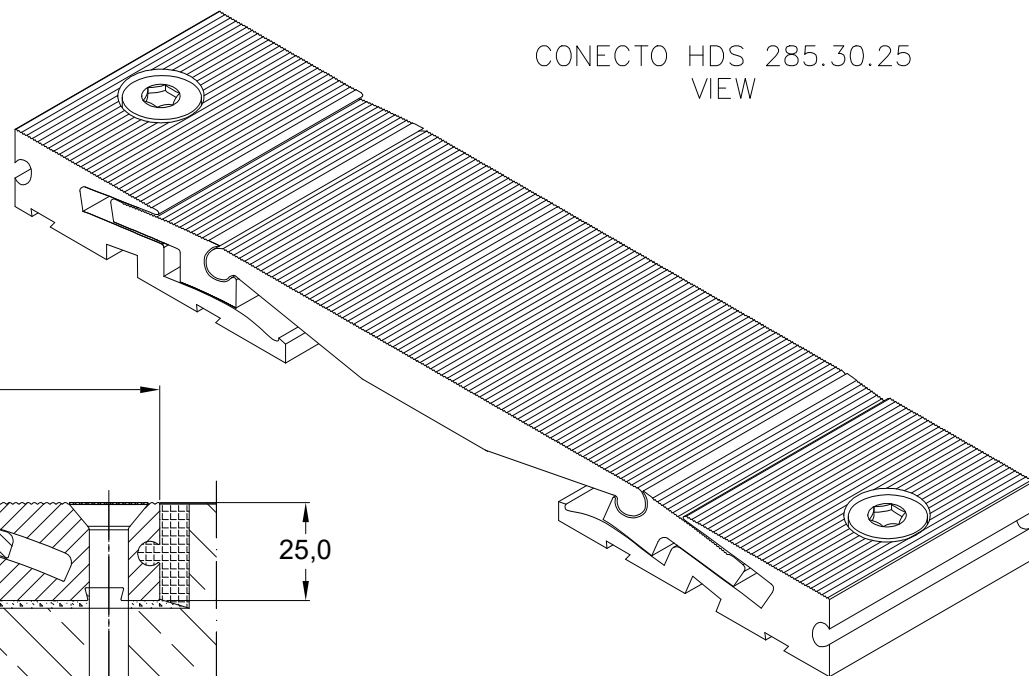

CONECTO HDS 285.30.25
SECTION

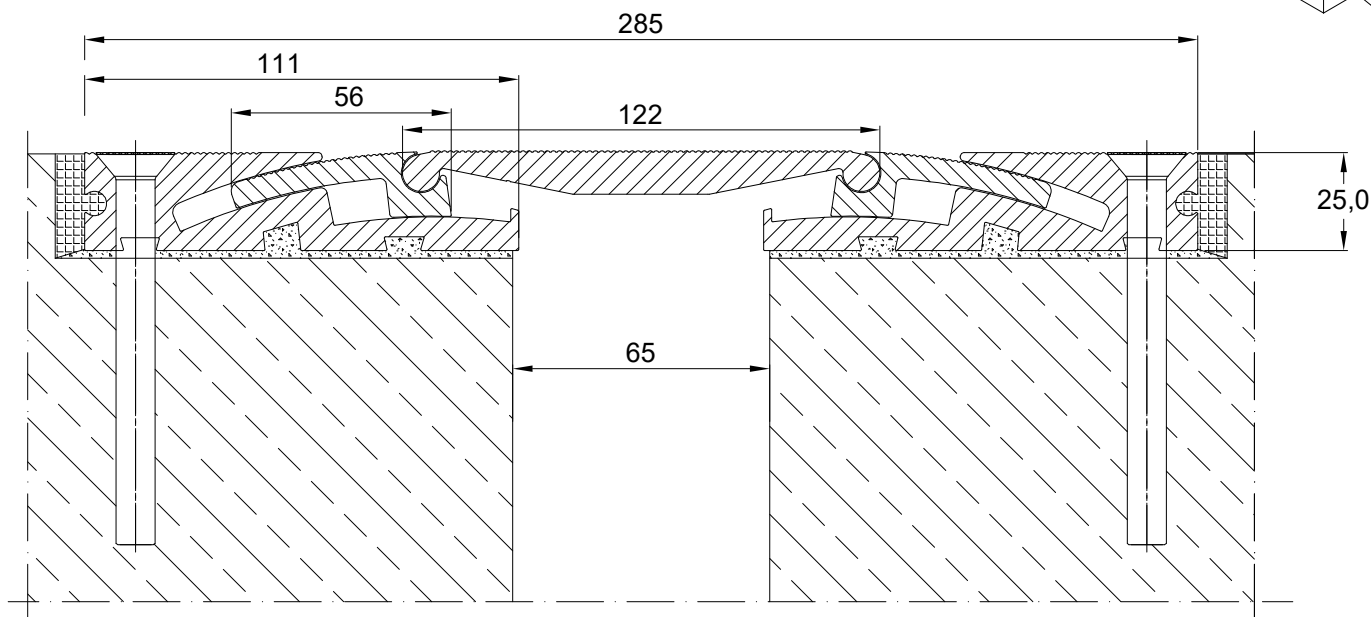

Expansion joint
Conecto HDS 285.30.25

Conecto Profiles Sp. z o.o.
ul. Przemysłowa 39
61-541 Poznań
www.conecto-profiles.com



ROZMIAR / SIZE A3	SKALA / SCALE 1:1	Wszystkie wymiary podano w [mm] All dimensions in [mm]
----------------------	----------------------	---

PROJEKT	PROJECT	ZŁOŻENIE	SUB ASSEMBLY	RYSUNEK	DRAWING	ARKUSZ SHEET	WER REV
--	--	--	--	01	01	1 Z OF 1	