

INFORMATION TABLE

Profile type	Visible element [mm]	Joint width [mm]	Base width [mm]	Installation height [mm]	Material type	Maximum load [kN]	Horizontal/vertical compensation [mm]
AL 110.15.22	110	max 75	225	22	Aluminum	100	32(±16) 42(±21)

CONECTO AL 110.15.22
VIEW

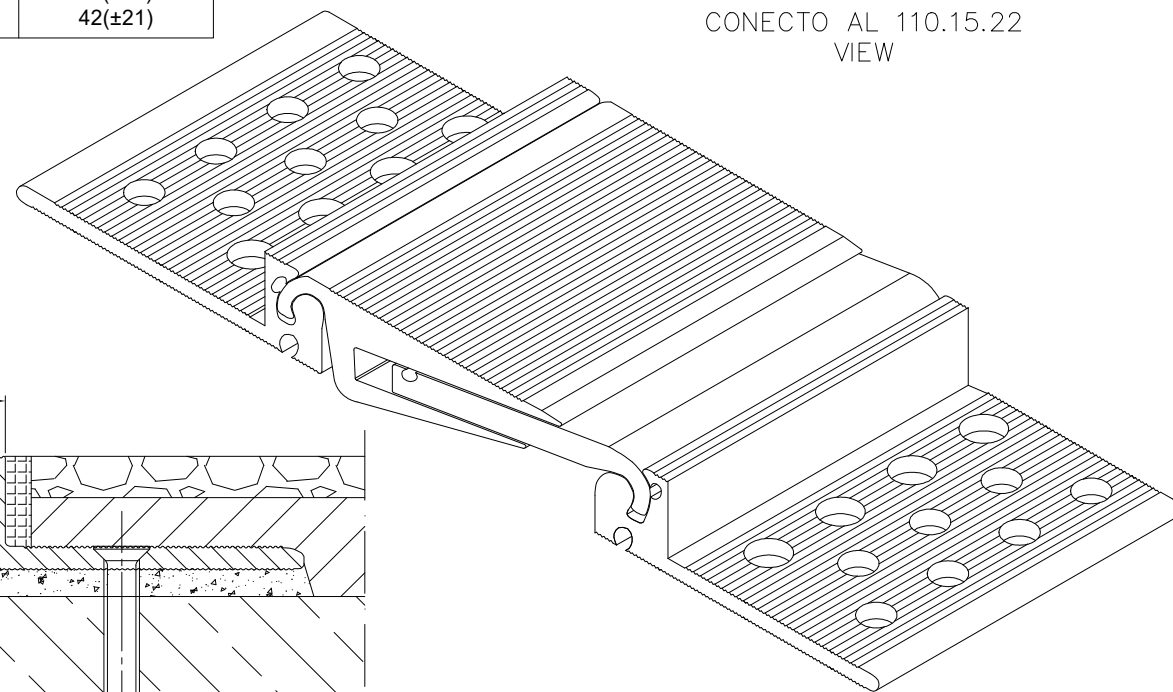

CONECTO AL 110.15.22
SECTION

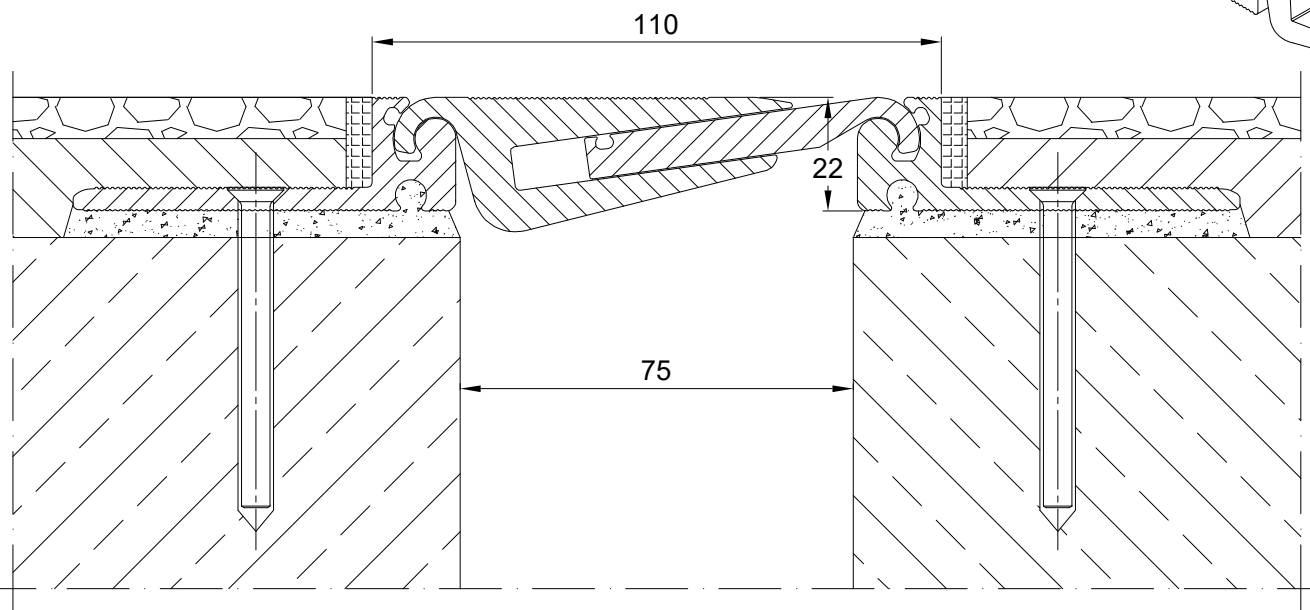

Expansion joint Conecto
AL 110.15.22

Conecto Profiles Sp. z o.o.
ul. Przemysłowa 39
61-541 Poznań
www.conecto-profiles.com



ROZMIAR / SIZE A3	SKALA / SCALE 1:1	Wszystkie wymiary podano w [mm] All dimensions in [mm]
----------------------	----------------------	---

PROJEKT	PROJECT	ZŁOŻENIE	SUB ASSEMBLY	RYSUNEK	DRAWING	ARKUSZ	SHEET	WER	REV
--		--		01		1	Z OF	1	